

**AEG**

# ÖKO-LAVAMAT 1576 T ELECTRONIC

The environmentally friendly washer-dryer  
La lavadora-secadora ecológica

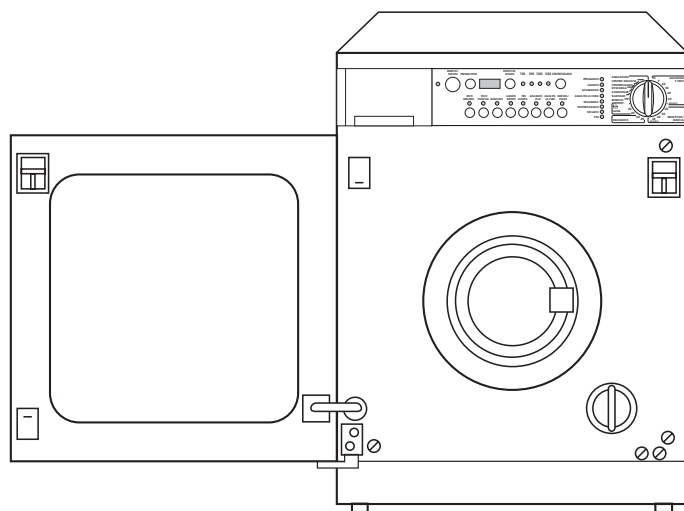



Instruction booklet  
Instrucciones para el uso



AUS ERFAHRUN GUT

## Dear customer,

Please read these operating instructions carefully and pay particular attention to the safety notes indicated in the first pages. We recommend that you keep this instruction booklet for future reference and pass it on to any future owners.

-  The warning triangle and/or the key words (Warning!, Caution!) emphasize information that is particularly important for your safety or correct functioning of the appliance.
-  This symbol guides you, step by step, in the operation of the appliance.
-  The information marked with this symbol provides additional instructions and practical tips on the use of the appliance.
-  Tips and information about economical and ecological use of the machine are marked with the clover symbol.

Should any problems arise, this booklet provides instructions on how to solve them by yourself; see section "Something not working?".

If this information is not sufficient, please contact our nearest SERVICE CENTRE (address and telephone numbers are indicated on the enclosed leaflet).

Printed on recycled paper.  
People who think ecologically, act accordingly...

## Contents

<b>Safety instructions</b> .....	6
<b>Disposal</b> .....	8
<b>Tips for environmental protection</b> .....	8
<b>Main features of your washer-dryer</b> .....	9
<b>Description of the appliance</b> .....	10
Control panel .....	11
Programme selector dial .....	11
ON/OFF button (MARCHA/PARADA) .....	12
Mains-on light .....	12
START/PAUSE button (MARCHA/PAUSA) .....	12
DELAY START button (PRESELECCION) .....	12
ELECTRONIC DRYING buttons .....	13
DRYING TIME button (TIEMPO DE SECADO) .....	13
Programme Option buttons .....	13
STAIN (MANCHAS) .....	13
QUICK (LAVADO RAPIDO) .....	14
PREWASH (PRELAVADO) .....	14
EXTRA RINSE (ACLARADO PLUS) .....	14
RINSE HOLD (AGUA EN LA CUBA) .....	14
SPIN SPEED (CENTRIFUGADO) .....	15
Display .....	15
Programme progress display .....	15
Cancelling a programme .....	16
Altering a programme which is running .....	16
Opening the door after the programme has started .....	16
Detergent dispenser drawer .....	17
<b>Before the first wash</b> .....	17
<b>Preparing the wash cycle</b> .....	18
Sorting out and preparing the laundry .....	18
Weight of laundry .....	19
Types of fabric and care labels .....	19
Detergents and additives .....	21
Which detergent and additive? .....	21
How much detergent? .....	21
Liquid detergent .....	21
Adding a water softener (descaling product) .....	21
Information on water hardness .....	21

<b>Preparing the drying cycle</b> .....	22
Load .....	22
Garments not suitable for drying .....	22
Drying symbols on garment labels .....	23
Duration of the drying cycle .....	23
Modification of the drying time or degree of drying .....	23
Fibre residue .....	23
Additional drying .....	24
Automatic washing and drying (NON-STOP programme) .....	24
<b>How to wash</b> .....	25
Load the laundry .....	25
Add detergent and additive .....	25
Switching the machine on .....	25
Selection of the desired wash programme .....	26
Selection of the spin speed .....	26
Selection of the STAIN, PREWASH or QUICK WASH option .....	26
Selection of the EXTRA RINSE and/or RINSE HOLD option .....	26
Selection of the DELAY START option .....	27
Starting the programme .....	27
At the end of the programme .....	28
<b>How to dry</b> .....	29
Drying only .....	29
Automatic washing and drying (NON-STOP programme) .....	29
<b>Programme charts: wash and special programmes</b> .....	30-31
<b>Programme chart: timed drying</b> .....	32
<b>Consumption data for timed drying</b> .....	33
<b>Cleaning and maintenance</b> .....	34
After each wash .....	34
Periodical cleaning .....	34
Exterior .....	34
Detergent dispenser drawer .....	34
Drain filter .....	35
Water inlet filter .....	35
Emergency emptying out .....	36
Frost precautions .....	36
<b>Something not working?</b> .....	37
Troubleshooting .....	37-40
Unsatisfactory washing results .....	41

<b>Technical data</b> .....	42
<b>Service</b> .....	43
<b>Instructions for installation and electrical connection</b> .....	44
Safety instructions for the installer .....	44
<b>Dimensions of the appliance</b> .....	45
Front view and side view .....	45
Rear view .....	45
<b>Installation</b> .....	46
Unpacking .....	46
Positioning .....	47
Levelling .....	47
Water inlet .....	48
Water drainage .....	48
Electrical connection .....	49
Permanent connection .....	49
Door reversal .....	50
Fitting a door panel .....	51

## Safety instructions

The safety of AEG appliances complies with the industry standards and with legal requirements on the safety of appliances. However, as manufacturers, we feel it is our duty to provide the following safety notes.

### General safety

- Repairs to the machine must be carried out only by qualified personnel. Repairs carried out by inexperienced persons could cause serious danger. Contact your local AEG Service Force Centre.
- Never start the machine if the electrical supply cable is damaged or the control panel or worktop are so damaged that inner components can be reached.
- Unplug the appliance before carrying out any cleaning or maintenance operations.
- Never pull the power supply cable to remove the plug from the socket; always take hold of the plug itself.
- Never spray the machine with a jet of water. Danger of electric shock!
- During high temperature wash programmes and during the drying cycle the door glass may get hot. Do not touch it!
- Let the water cool down before carrying out emergency emptying or before opening the door in an emergency.
- Small animals can gnaw electric wires and water hoses causing electrocution hazard and damage due to water leaks.

### Positioning, connection, starting up

- Follow the **instructions for positioning and connection**.
- Carry out a first wash without laundry (COTTONS 60, with half the amount of detergent) in order to remove any manufacturing residue from the tub and the drum.
- Should the machine be purchased in winter, when temperatures can be below 0°, leave the appliance for 24 hours at ambient temperature before starting it.

### Child safety

- Children are often not aware of how dangerous electrical appliances can be. When the machine is working, children should be carefully supervised and not be allowed to play with the appliance - there is a risk that they could become trapped inside.
- The packaging components (e.g. plastic film, polystyrene) can be dangerous to children - danger of suffocation! Keep them out of children's reach.
- Keep all detergents in a safe place out of children's reach.
- Make sure that children or pets do not climb into the drum.
- When the appliance is to be scrapped, cut off the electrical supply cable and destroy the plug with the remaining cable. Disable the door catch in order to prevent children from becoming trapped inside while playing.

### Proper use

- This appliance is designed for domestic use only. If the machine is used for any other purposes or is not used correctly, the manufacturer accepts no responsibility for any damage that might occur.
- For safety reasons, the appliance must not be modified.
- Use only detergents suitable for washing machines and follow the manufacturer's instructions.
- Garments which have been in contact with flammable solvents should not be machine washed.
- Do not use your machine for dry cleaning.
- Dyes and bleaching agents may only be used if specifically permitted by the manufacturer of these products. We cannot be held responsible for any damage.
- Always unplug the appliance and turn off the water tap after use.



## Disposal

### Packaging materials

The materials marked with the symbol ♻ are recyclable.

>PE<=polyethylene

>PS<=polystyrene

>PP<=polypropylene

This means that they can be recycled by disposing of them properly in appropriate collection containers.

### Machine

Use authorised disposal sites for your old appliance. Help to keep your country tidy!



## Tips for environmental protection

To save water, energy and to help protect the environment, we recommend that you follow these tips:

- Normally soiled laundry may be washed without prewashing in order to save detergent, water and time (the environment is protected too!).
- Use the energy saving programme when washing normally soiled garments.
- The machine works more economically if it is fully loaded (for both washing and drying cycles).
- When small loads are washed, use only half to two thirds of the recommended amount of detergent.
- The machine will consume less energy if the laundry is **adequately spun** before being dried.
- With adequate pre-treatment, stains and limited soiling can be removed; the laundry can then be washed at a lower temperature.
- If the water has a medium or high degree of hardness (starting from hardness degree II, see "Detergents and additives") water softeners must be added.  
The amount of detergent can then be adjusted to hardness degree I (= soft).

## Main features of your washer-dryer

- Programme and temperature setting using the programme selector.
- **Stain programme** for effectively treating stained washing.
- **Energy saving programme** for normally soiled cotton items.
- **Speed for the final spin** can be reduced to 1200, 900 or 700 rpm.
- **RINSE HOLD**: the laundry is left immersed in the final rinse water to prevent creasing.
- **Delay timer**: programme start can be delayed by 1 to 19 hours (e.g. to times with a more economical power rate).
- **Programme progress display** showing the programme steps selected and the programme phase which is running.
- Because of its gentle washing action, the **special wool cycle** washes your garments with extreme care.
- **The drying programmes** will enable you to have dry and soft laundry in a short time.
- **3-compartment drawer** for detergent and fabric softener.
- **Unbalance detection device**: to prevent vibration during spinning.

## Description of the appliance

### Front view

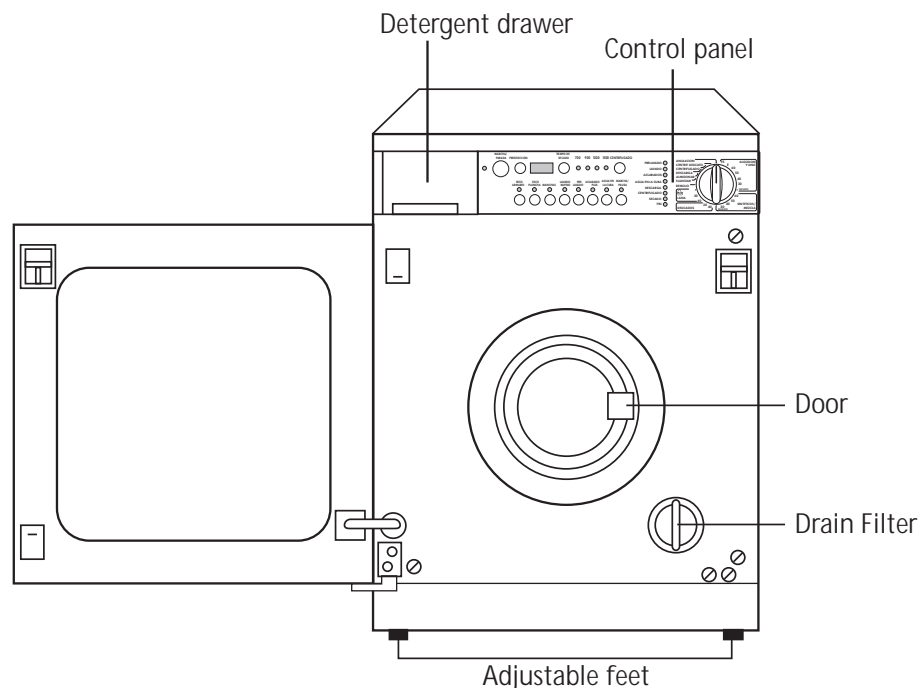

## Control panel

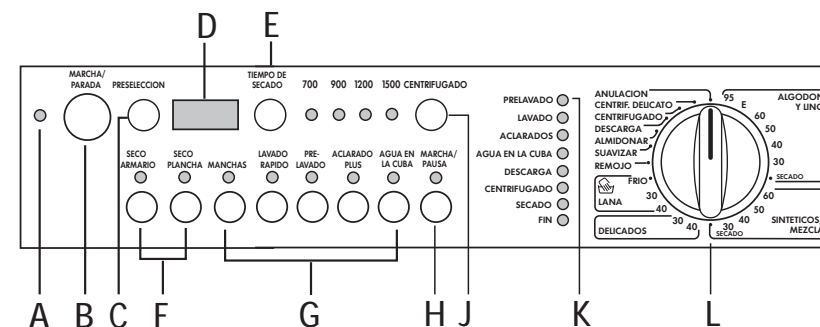

- A = Mains-on light
- B = ON/OFF button
- C = Delay start button
- D = Display
- E = Drying time button
- F = Electronic drying buttons
- G = Option buttons
- H = START/PAUSE button
- J = Spin speed button
- K = Programme progress display
- L = Programme selector dial

### Programme selector dial

The programme selector determines the type of washing cycle (e.g. water level, drum movement, number of rinses), the washing temperature and enables the required drying programme to be selected according to the type of laundry.

The selector is divided into 5 sections:

- Cottons (Algodón y lino)
- Synthetics (Sintéticos, mezcla)
- Delicates (Delicados)
- Woollens  (hand washing) (Lana)
- Special programmes
- Reset programme (Anulación)

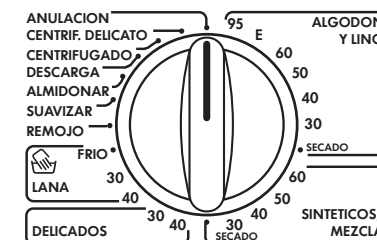

The selector dial can be turned either clockwise or anticlockwise.



Position **E** corresponds to the ENERGY SAVING programme at approx. 67°C for normally soiled laundry, extended washing time [cannot be combined with STAIN (MANCHAS) and QUICK (LAVADO RAPIDO)].

### ON/OFF button (MARCHA/PARADA)

Press this button to switch the machine on. Press it again to switch the machine off.

### Mains-on light

This light comes on when the ON/OFF button is pressed, and goes out when it is pressed again.

### START/PAUSE button (MARCHA/PAUSA)

This button has three functions:

#### a) Start

After having selected the required programme, press this button to start the machine; the corresponding pilot light stops flashing.

#### b) Pause

To interrupt a programme which is running, press the START/PAUSE button: the corresponding pilot light and the light of the programme phase which is running will start to flash.

To restart the programme from the point at which it was interrupted, **press the START/PAUSE button again.**

#### c) Empty out water

At the end of a programme which ends with water in the drum [AGUA EN LA CUBA (RINSE HOLD) option], or after the "soak" programme (REMOJO), press the START/PAUSE button to empty out the water: after the soak programme, the machine will empty only; after programmes which end with water in drum, the machine will empty and spin.

### DELAY START button (PRESELECCION)

The wash programme can be delayed from 1 hour up to a maximum of 19 hours.

**The button must be pressed after selecting the programme and before pressing the START/PAUSE button.**

The figures indicating the delay appear for about 2 seconds in the display next to the button. The duration of the selected wash programme is then displayed. One minute after depressing the START/PAUSE button, the machine starts its hourly countdown.

During the last hour, the remaining time is displayed every 5 minutes. The delayed start function **cannot** be used with the "CENTRIFUGADO" and "DESCARGA" (SPIN and PUMP OUT) programmes.

To alter or cancel the preset delay, press the START/PAUSE button, then press the DELAY START button until the required time is displayed or, if you wish to cancel the delay, until the symbol 0h is displayed.

Then press the START/PAUSE button again.

When the delay is cancelled, the display shows the duration of the wash programme previously selected.

### ELECTRONIC DRYING buttons

By means of these buttons you can choose the required degree of drying for cottons and synthetics:

- SECO ARMARIO (Store dry)
- SECO PLANCHA (Iron dry).

The drying time is automatically adjusted by the machine: the laundry will be dried to the selected degree of dryness.

### DRYING TIME button (TIEMPO DE SECADO)

If you wish to carry out a timed programme instead of an electronic programme push the button until the drying time you want appears in the display according to the fabrics (cotton or synthetics) you have to dry.

For **COTTON** you can select a drying time from 10 minutes to 2 hours and 10 minutes (2.10).

For **SYNTHETICS** you can select a time from 10 minutes to 1 hour and 40 minutes (1.40).

### Programme Option buttons

Depending on the programme, different functions can be combined. These must be selected after choosing the desired programme and before depressing the START/PAUSE button.

When these buttons are pressed, the corresponding pilot lights come on. When they are pressed again, the pilot lights go out.

If an incorrect option is selected, the pilot lights flash for about 3 seconds and the message **Err** is displayed.

### STAIN (MANCHAS)

To treat heavily soiled washing or stained washing with stain remover (extended main wash with time optimised stain action phase, **not** selectable for wool or programmes with temperatures lower than 40°C).

## QUICK (LAVADO RAPIDO)

By pressing this button the washing time is reduced. For use when washing lightly soiled laundry.

This option is **not** available with the wool programme.

## PREWASH (PRELAVADO)

The machine performs a prewash cycle at 40°C max. The prewash cycle ends with a short spin in programmes for Cotton and Synthetics, and with emptying of the water only for Delicates.

This option is **not** available with the wool programme.

For use when washing heavily soiled laundry.

**Important:** the STAIN, PREWASH and QUICK WASH options **cannot** be selected together: one automatically disables the others.

## EXTRA RINSE (ACLARADO PLUS)

Can be used with all programmes **except the wool programme**. The machine performs 4 rinses instead of 3.

This option is recommended for people who are allergic to detergents and in areas where the water is very soft.

## RINSE HOLD (AGUA EN LA CUBA)

When this button is pressed, the last rinse water is not emptied out, to prevent the fabrics from creasing. When the programme has finished, the corresponding pilot light on the programme progress display flashes to indicate that the water must be emptied out.

To empty out water:

- press the START/PAUSE button: after emptying, the machine performs the spin cycle required for the type of wash selected;
- select the PUMP OUT programme (DESCARGA) to empty out the water without spinning.

**Warning!** The programme selector dial must be turned first to ANULACION (RESET) and then to the DRAIN programme "DESCARGA".

**This option can also be selected for the wool programme: the last rinse water is emptied out but the machine does not spin.**

**If the water is not emptied out, the machine automatically empties itself after 18 hours.**

The RINSE HOLD option **cannot** be selected for the automatic WASHING & DRYING programme.

## SPIN SPEED (CENTRIFUGADO)

Press this button to reduce the maximum speed of the final speed proposed by the machine for the selected programme.

The maximum spin speed for cotton is 1500 rpm, for synthetics and wool 900 rpm and for delicates 700 rpm.

## Display

The display shows the following information:

- if the programme selector dial is on the ANULACION (RESET) position, **three flashing dashes** appear immediately after pressing the ON/OFF button to indicate that the machine is ready to receive instructions for the required wash programme.
- **Duration of the selected wash programme**, calculated automatically on the basis of the maximum recommended load for each type of fabric.
- **Selected drying time** (max. 2 hours and 10 minutes for cotton, 1 hour and 40 minutes for synthetics).  
After the programme has started, the time remaining is updated every 10 minutes, and every 5 minutes during the last 20 minutes.
- When the programme has finished, **three flashing zeros** are displayed.
- **Delayed start**, programmed using the special button PRESELECCION (DELAY START).  
The selected delay (19 hours max.) is indicated in the display. The countdown is updated every hour, and every 5 minutes during the last hour.
- **Heating phase**. A dot to the right of the figures in the display indicates that the machine is heating the water.
- **Incorrect option selection**. If an option which is not compatible with the set wash programme is selected, the message **Err** is displayed.

## Programme progress display

By selecting the wash programme, the pilot lights corresponding to the various phases making up the programme come on.

After the machine has started, only the running phase pilot light stays on. When the programme has finished, the END (FIN) pilot light comes on.

PRELAVADO	●	PREWASH
LAVADO	●	WASH
ACLARADOS	●	RINSES
AGUA EN LA CUBA	●	RINSE HOLD
DESCARGA	●	PUMP OUT
CENTRIFUGADO	●	SPIN
SECADO	●	DRY
FIN	●	END



## Cancelling a programme

To cancel a programme which is running, turn the programme selector dial to the ANULACION (RESET) position: three flashing dashes will be displayed.

**Warning!** After a programme which ends with water in the drum (RINSE HOLD option), turn the selector dial first to ANULACION (RESET) and then to the PUMP OUT programme.

## Altering a programme which is running

To alter a programme, first set the machine to PAUSE by pressing the START/PAUSE button.

Before the machine starts the heating phase, i.e. within the first 15 minutes for cotton programmes, 10 minutes for synthetic and delicate programmes and 5 minutes for the wool programme, the selected wash cycle can be modified.

**Warning!** If the programme selector dial is turned first to ANULACION (RESET) and then to the new programme, the programme which is running is cancelled, the water is emptied out and the machine re-starts from water filling. To simply modify the programme which is running, turn the programme selector dial to the desired position (avoiding the RESET position): when the START/PAUSE button is pressed again, the machine restarts with the newly selected programme from the point at which it was interrupted.

## Opening the door after the programme has started

The door can only be opened before the machine starts the heating phase (within the first 15, 10 or 5 minutes, depending on the programme selected - see paragraph above) and during the rinse phase.



Set the machine to PAUSE (by pressing the START/PAUSE button).

If the door does not open, this means that the machine is already heating, or that the water level is above the bottom edge of the door.

This prevents water from spilling out when the door is opened.

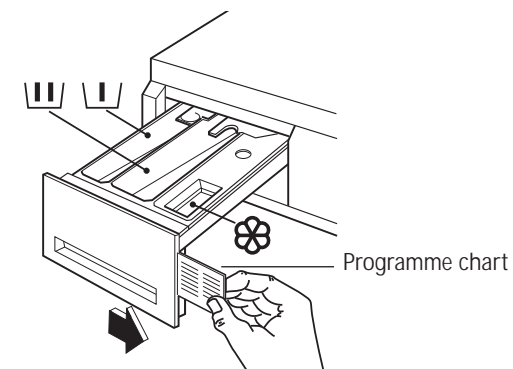
## Detergent dispenser drawer



-  Compartment for prewash or soak detergent and stain remover. The prewash or soak detergent is added at the beginning of the wash programme. The stain remover is added during the STAIN-Action phase in the main wash.
  -  Compartment for powder or liquid detergent used for main wash. It is emptied at the beginning of the wash cycle.
  -  Compartment for liquid additives (fabric softener, starch). It is emptied at the last rinse.
- The quantity of additives must not exceed the "MAX" mark in the drawer.**

## Before the first wash

Before your first wash, we recommend that you run a cotton cycle at 60°C, **without any laundry in the machine**, to remove any manufacturing residue from the drum and tub.

Pour 1/2 a measure of detergent into the dispenser drawer and start the machine.

## Preparing the wash cycle

### Sorting out and preparing the laundry

- Sort out the laundry according to type of fabrics and care labels (see "Types of fabric and care labels").
- Empty pockets.
- Remove any metal parts (safety pins, clips, etc.).
- To prevent the laundry from getting damaged and forming bundles, it is advisable to close zips, button up pillowcases and quilt covers and tie up loose straps such as those of aprons.
- Turn double faced items inside out (sleeping bags, anoraks, etc.)
- Turn coloured knitted fabrics, woollens and fabrics with trim inside out.
- Wash small and delicate items (baby socks, tights) inside a laundry net or in a pillow case closed with a zip, or in larger socks.
- Treat curtains with special care. Remove all metal or plastic hooks or put them in a net or a bag. We take no responsibility for any damage.
- Whites and coloureds must be washed separately: white items can lose their whiteness.
- New coloured fabrics often have excess dyes; it is advisable to wash them separately for the first time.
- Wash small and large items together; this improves the washing result and the laundry is better distributed during spinning.
- Shake out garments before putting them into the machine.
- Insert each garment separately.

## Weight of laundry

Sort of laundry	Approximate dry weights
Bathrobes	1200 g
Work shirts	300-600 g
Quilt covers	700 g
Sheets	500 g
Blouses	100 g
Hand towels	200 g
Tea towels	100 g
Shirts	200 g
Pillowcases	200 g
Night-gowns/Pyjamas	200-250 g
Tablecloths	200-300 g
Underwear	250 g

### Types of fabric and care labels

The labels on garments help you to select the most suitable wash programme. The laundry should be sorted out according to the type of fabric and the instructions indicated on care labels.

Temperatures indicated on labels are always maximum temperatures.

#### Cotton

Linen and cottons marked with this symbol can be washed at high temperatures.

#### Cotton

Linen and cottons marked with this symbol are colourfast and can be washed at 60°C.

#### Cotton

Garments marked with these symbols have delicate colours, therefore the washing temperature must not exceed these values.

#### Synthetics

Mixed and synthetic fabrics marked with these symbols require a gentle wash programme and they must therefore be washed using the specific programme.

**Delicates**  

Microfibres, synthetics or curtains marked with these symbols require a very gentle treatment.

The DELICATES programme is suitable for this type of fabric.

**Woollens and particularly delicate items**    

Fabrics such as wool, wool mix or silk marked with this symbol are particularly sensitive to machine washing.

The WOOLLENS programme is suitable for this type of fabric.

If the label has the symbol  (do not wash), the garments must not be machine washed!

## Detergents and additives

### Which detergent and additive?

Use only detergents and additives for washing machines. Follow the manufacturer's instructions.

### How much detergent?

The quantity depends on:

- the load:  
if the manufacturer does not provide any indications on the amount of detergent for small loads, use about one third less than the suggested amount for half loads and half the amount for very small loads;
- the degree of soil:  
use a small amount of detergent for lightly soiled garments. Judge the amount according to the detergent manufacturer's instructions and size of the load;
- the water hardness:  
the harder the water, the more detergent required. Instructions according to water hardness are given on the detergent pack.

### Liquid detergent

Liquid detergent can be poured directly into the main wash compartment of the dispenser drawer **immediately** before starting the programme, or a special dispenser can be used that is placed directly in the drum. Measure the detergent according to the manufacturer's instructions.

### Adding a water softener (descaling product)

A water softener must be added when water has a medium-high degree of hardness (from degree of hardness II). Follow the manufacturer's instructions. The quantity of detergent can then always be adjusted to degree of hardness I (= soft). Information on water hardness can be obtained from your local water supply authority.

### Information on water hardness

Degree of hardness	German degrees °dH	French degrees °TH
I=Soft	0-7	0-15
II=Medium	7-14	16-25
III=Hard	14-21	26-37
IV=Very hard	more than 21	more than 37

## Preparing the drying cycle

As a dryer, the machine works on the condensation principle.

Therefore, **the water tap must be open and the drain hose must drain water into a sink or into the drain pipe, even during the drying cycle.**

### Load

Sort of laundry	max. load (dry weight)
Linen and cottons	2.5 kg
Synthetics	2 kg

#### Warning:

**Loads of washed laundry exceeding these values must be divided before being dried, otherwise poor results will be obtained.**

### Garments not suitable for drying

- Particularly delicate items such as synthetic curtains, woollen and silk, garments with metal inserts, nylon stockings, bulky garments such as anoraks, bedcovers, quilts, sleeping bags and duvets must not be machine dried.
- Garments padded with foam-rubber or materials similar to foam-rubber must not be machine dried; they represent a fire hazard.
- Also, fabrics containing residues of setting lotions or hair sprays, nail solvents or similar solutions must not be machine dried in order to avoid the formation of harmful vapours.

## Drying symbols on garment labels

Always look at the garment label to check whether garments can be machine dried.

The following symbols refer to drying:



Machine drying is usually possible



Normal drying (normal temperature)



Gentle drying (reduced temperature)



Do not machine dry

Garments marked with the symbol  should not be machine dried.

## Duration of the drying cycle

The drying time can vary according to

- the final spin speed;
- the required degree of drying (extra dry, only for cottons with timed programme, store dry or iron dry);
- the type of laundry;
- the size of load.

The usual drying times for the timed programmes are indicated in the programme chart. As you become more familiar with the appliance, you will discover the drying times that best suit your needs according to the various type of fabric. It is a good idea to make a note of these times.

## Modification of the drying time or degree of drying

If you wish to modify the drying time or the degree of drying when a drying programme is running, first depress START/PAUSE button to set the machine to PAUSE. After modifying the time or degree, depress START/PAUSE again to continue the programme.

## Fibre residue

After drying fluffy fabrics, such as new towels, it is advisable to perform a gentle rinse (SUAVIZAR) to be sure that any residue that may remain in the tub is completely removed and does not stick to garments dried afterwards.

**After each drying cycle the filter should be checked and cleaned.**

## Additional drying

Should the laundry still be too wet at the end of the programme, set another short drying time.

**Warning!** To prevent the formation of creases or shrinking of fabrics, avoid excessive drying.

## Automatic washing and drying (NON-STOP programme)

The NON-STOP programme can be used with

- cottons, linen
- synthetics

It cannot be used for delicate fabrics and woollens.



**Warning:** the maximum load sizes for NON-STOP operation - washing plus drying - are as follows:

- |                     |            |
|---------------------|------------|
| - cottons and linen | max 2.5 kg |
| - synthetics        | max 2 kg   |



The drying time or degree of dryness has to be selected after choosing the wash programme.

## How to wash

### Load the laundry

-  Open the door.
-  Place the laundry in the drum, one item at a time. Distribute laundry as evenly as possible. Close the door.

### Add detergent and additive

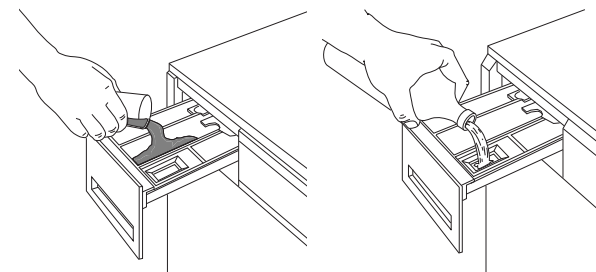

-  Pull the drawer out till it stops.
-  Pour the main wash detergent into compartment .



If you wish to perform a pre-wash, or a STAIN-Action programme, pour detergent or stain remover into compartment .

#### Important!

**Do not use normal detergent for the STAIN-Action programme, always use a STAIN remover.**

-  Pour the fabric softener into compartment  without exceeding the "MAX" mark.
-  Close the drawer, pushing it fully in.

### Switching the machine on

-  To switch the machine on, press the MARCHA PARADA (ON/OFF) button: if the programme selector dial is on the ANULACION (RESET) position, three flashing dashes will be displayed. If the programme selector dial is positioned on a wash programme, the duration of that programme will be displayed.

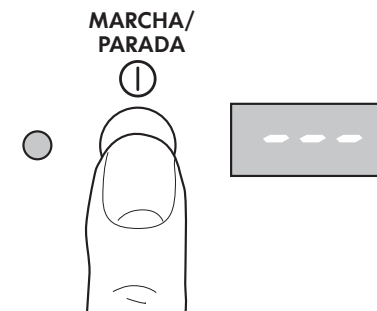

### Selection of the desired wash programme

Turn the programme selector dial to the desired position: the lights corresponding to the different phases making up the selected programme light on.

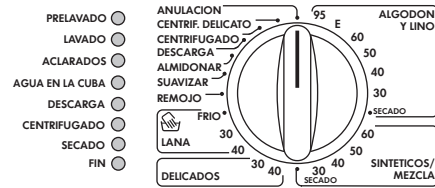

### Selection of the spin speed

To select the desired spin speed, press the CENTRIFUGADO (SPIN SPEED) button: the corresponding light comes on.

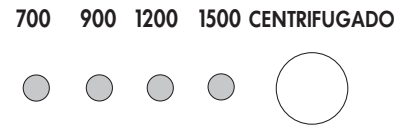

**Selection of the STAIN, PREWASH or QUICK WASH option**, depending on the degree of soil of the laundry and on the type of fabric. The corresponding light comes on.

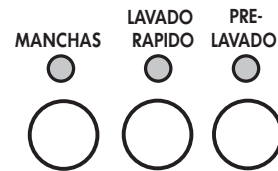

### Selection of the EXTRA RINSE and/or RINSE HOLD option

The corresponding light(s) come on.

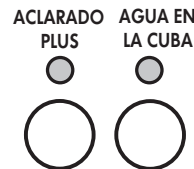

### Selection of the DELAY START option

To delay starting of a programme, press the DELAY START button **before starting the machine**. The figures corresponding to the selected delay will be displayed for about 2 seconds, after which the duration of the selected programme will appear on the display. When the START/PAUSE button is pressed, the selected delay will again appear on the display and the machine starts its countdown.



### Starting the programme

To start the selected programme, press the START/PAUSE button; the corresponding light stops flashing. The pilot light corresponding to the wash phase which is running is on. After about 30 seconds the programme starts.

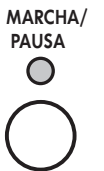

## At the end of the programme

The machine stops automatically and three flashing zeros are displayed. The FIN (END) and spin speed pilot lights, as well as the pilot light(s) corresponding to the selected option(s), stay on.

- ☞ If the RINSE HOLD option has been selected, the corresponding pilot light on the programme progress display flashes to indicate that the water must be emptied out before opening the door. The pilot light of the START button flashes and three flashing zeros are displayed. Release of the lock is indicated by an audible signal.
- ☞ Turn the programme selector dial to ANULACION (RESET).
- ☞ Switch the machine off by pressing the ON/OFF button.
- ☞ Remove the laundry from the drum. Check that the drum is empty so as to avoid a subsequent wash being damaged by any forgotten items.
- ☞ Close the water tap.
- ☞ Leave the door open to prevent the formation of mildew and unpleasant smells.

## **i** How to dry

### Drying only

**Warning!** Do not exceed the maximum laundry loads:

- 2.5 kg for linen and cottons
- 2 kg for synthetics.

The water tap must be open and the drain hose must be positioned in the sink or connected to the drain pipe.

- ☞ Depress the ON/OFF button to switch the machine on.
- ☞ Select the drying programme (for cotton or synthetics).
- ☞ Depress the DRYING TIME button until the time you want appears in the display (for timed drying).



- ☞ If you wish to carry out the electronic drying, depress the button corresponding to the degree of dryness required.
- ☞ Press the START/PAUSE button to start the programme.
- ☞ At the end of the cycle, turn the programme selector dial to ANULACION and press the ON/OFF button again to switch the appliance off.
- ☞ Remove the laundry.

## **i** Automatic washing and drying (NON-STOP programme)

**Warning!** For NON-STOP programmes, it is also essential not to exceed the maximum load sizes of 2.5 kg for cotton and 2 kg for synthetics.

**If you use a dosing device in a washer-dryer, please ensure the dosing device/ball is removed before carrying out a drying programme.**

- ☞ Load the laundry.
- ☞ Add detergent and additive.
- ☞ Switch the machine on by depressing the ON/OFF button.
- ☞ Select the wash programme.
- ☞ Select eventually the required options by means of the relevant buttons. If possible, do not select a spin speed lower than that proposed by the appliance to avoid a too long drying time so saving energy.
- ☞ Select the drying time or degree of drying.
- ☞ Start the programme by depressing the START/PAUSE button.
- ☞ At the end of the programme, turn the selector dial to ANULACION and press the ON/OFF button again to switch the machine off.
- ☞ Remove the laundry.

## Programme chart

### Wash programmes

Wash programme	Temp.	Fabrics	Additional functions	Max. load	Consumption*		
					Energy kWh	Water lt.	Duration min.
White Cottons (Algodón Blancos)	95°-60°	Cotton and linen, for example normally soiled work garments, sheets, household linen, underwear, towels.	STAIN QUICK PREWASH RINSE PLUS RINSE HOLD SPIN SPEED	5 kg	2.2	48	160
<b>E</b> Whites ECONOMY (Blancos ECONOMIA)	60°	Cotton and linen, for example normally to lightly soiled sheets and household linen.	PREWASH RINSE PLUS RINSE HOLD SPIN SPEED	5 kg	1.8	45	160
Coloured cottons (Algodón de color)	60°-50° 40°-30°	Coloured cotton or linen fabric, shirts, underwear, towels.	STAIN QUICK PREWASH RINSE PLUS RINSE HOLD SPIN SPEED	5 kg	1.15	45	135
Synthetics (Sintéticos)	60°-50° 40°-30°	Synthetic fabrics, underwear, coloured garments, non-shrink shirts, blouses.	STAIN QUICK PREWASH RINSE PLUS RINSE HOLD SPIN SPEED	2 kg	1.1	60	90
Delicates (Delicados)	40°-30°	Delicate fabrics, for example curtains.	STAIN QUICK PREWASH RINSE PLUS RINSE HOLD	2 kg	0.6	55	60
Wool (Lana)	40°-30 COLD (FRIO)	Wool, mixt wool, silk.	RINSE HOLD SPIN SPEED	1 kg	0.4	50	60

#### ECONOMY

Select the economy programme "E" instead of the 95°C programme when washing normally soiled whites; the wash is carried out at about 67°C, with consequent energy saving. The washing phase will be slightly longer.

In compliance with EC directive 92/75, the consumption figures indicated on the energy label refer to the 60°C wash programme for cotton.

\* The consumption data shown on this chart is to be considered purely indicative, as it may vary depending on the quantity and type of laundry, on the inlet water temperature and on the ambient temperature. It corresponds to the highest temperature for each wash programme.

## Programme chart

### Special programmes

Programme	Type of laundry	Programme phases	Additional functions	Max. load	Consumption*		
					Energy kWh	Water lt.	Duration min.
Soak (Remojo)	Heavily soiled fabrics, except wool.	Soak at 40°C. Stop with water in drum. <b>To empty only:</b> press the START/PAUSE button. <b>To empty and spin:</b> select the desired spin speed and press the START/PAUSE button. The machine automatically empties itself after 18 hours.		5 kg	0.8	24	28
Gentle rinses (Suavizar)	This programme can be used for rinsing hand washed garments.	3 rinses with liquid additive. Short spin. (700 rpm max)	RINSE PLUS RINSE HOLD SPIN	5 kg	0.02	42	20
Softeners (Almidonar)	Hand washed garments to be starched or softened.	1 rinse with liquid additive. Spin.	RINSE HOLD SPIN SPEED	5 kg	0.04	19	20
Pump out (Descarga)	For emptying out the last rinse water in programmes with the Rinse Hold option.	The water is emptied out.		/		/	2.5
Spin (Centrifugado)	Separate spin for all fabrics.	Spin.	SPIN SPEED	5 kg	0.03	/	10
Short spin (Centrifugado delicado)	Separate spin for synthetics and delicate fabrics.	Short spin. (700 rpm max)		2 kg			5
Reset (Anulación)	Cancel.	For cancelling the wash programme which is running.					

\* The consumption data shown on this chart is to be considered purely indicative, as it may vary depending on the quantity and type of laundry, on the inlet water temperature and on the ambient temperature.



## Programme chart

### Timed Drying

Degree of drying	Type of fabric	Max. load	Spin speed	Drying time mins
Extra dry Ideal for towelling materials	Cotton and linen (bathrobes, bath towels, etc.)	2.5 kg	<b>1200</b> <b>1500</b>	80-90 75-85
		1 kg	<b>1200</b> <b>1500</b>	50-60 45-55
Store dry (*) Suitable for items to put away without ironing	Cotton and linen (towels, T-shirts, bathrobes)	2.5 kg	<b>1200</b> <b>1500</b>	70-80 65-75
		1 kg	<b>1200</b> <b>1500</b>	40-50 35-45
	Synthetics and mixed fabrics (jumpers, blouses, underwear, household linen)	2 kg	<b>900</b>	85-95
		1 kg	<b>900</b>	55-65
Iron dry Suitable for ironing	Cotton and linen (sheets, tablecloths, shirts, etc.)	2.5 kg	<b>1200</b> <b>1500</b>	50-60 45-55
		1 kg	<b>1200</b> <b>1500</b>	30-40 25-35
	Synthetics and mixed fabrics (shirts, blouses, household linen)	2 kg	<b>900</b>	70-80
		1 kg	<b>900</b>	40-50

(\*) The STORE DRY drying programme for cotton is the reference programme for the Energy Label data, in compliance with standard EEC 92/75.

## Consumption data for timed drying

The values shown in the chart have been obtained in laboratory tests. They may vary when the appliance is used at home, but they can be used as indicative values.

Degree of drying	Spin speed	Max load	Water litres	Energy kWh	Duration minutes
Cotton Extra dry	<b>1500</b>	2.5 kg	25	1.9	75-85
Cotton Store dry	<b>1500</b>	2.5 kg	20	1.5	65-75
Cotton Iron dry	<b>1500</b>	2.5 kg	15	1.1	45-55
Synthetics Store dry	<b>900</b>	2 kg	25	1.1	85-95
Synthetics Iron dry	<b>900</b>	2 kg	21	0.8	70-80

## Cleaning and maintenance

### After each wash

- ☞ At the end of the wash programme, pull the dispenser drawer out a little to let it dry.
- ☞ Leave the door ajar to allow air to circulate.

### If the machine is not used for a prolonged period:

- ☞ Close the water tap and unplug the appliance.

### Periodical cleaning

#### Exterior

- ☞ Clean the outside of the cabinet with soap and water only. Rinse with clean water and dry.

**Important:** do not use methylated spirits, solvents or similar products to clean the cabinet.

#### Detergent dispenser drawer

After a while, detergents and fabric softeners leave deposits in the drawer.

- ☞ Clean the drawer, from time to time, by rinsing it under a running tap. To remove the drawer from the machine, press the button in the rear left-hand corner.
- ☞ To facilitate cleaning, the top part of the additive compartment can be removed.
- ☞ Detergent can also accumulate inside the drawer recess: clean it with an old toothbrush.
- ☞ Refit the drawer after cleaning.

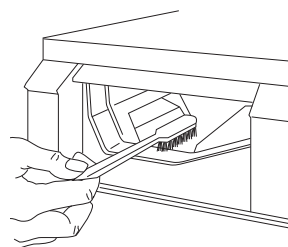
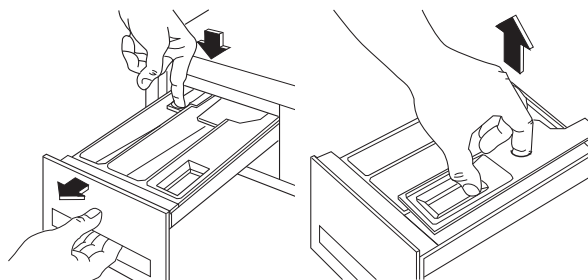

### Drain filter

The drain filter collects threads and small objects inadvertently left in the laundry. Check regularly that the filter is clean.

- ☞ Open the door of the machine.
- ☞ Place a container under the filter and unscrew it; some water will come out of the filter.

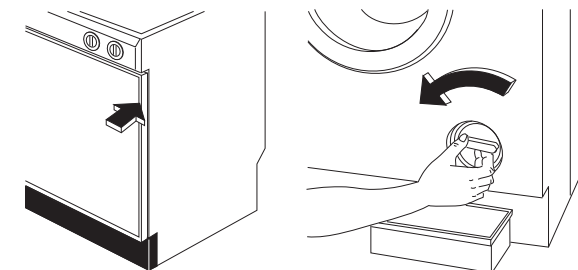

- ☞ Pull out the filter.
- ☞ Clean the filter under a running tap, then refit it, screwing it fully in.

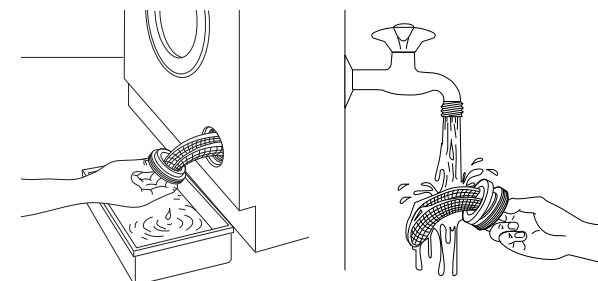

### Water inlet filter

If you notice that the machine is taking longer to fill, check that the filter in the water inlet hose is not blocked.

- ☞ Turn off the water tap.
- ☞ Unscrew the hose from the tap and remove the filter.
- ☞ Clean it with a stiff brush.
- ☞ Refit the filter and screw the hose back onto the tap.

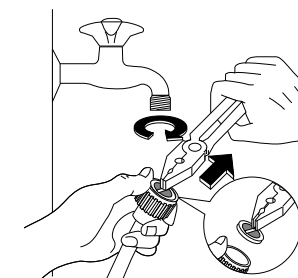

## Emergency emptying out

If the water is not discharged (pump is blocked, filter or drain hose are clogged), proceed as follows to empty out the machine:

- pull out the plug from the power socket;
- close the water tap;
- if necessary, wait until the water has cooled;
- place a bowl on the floor;
- put the drain hose end into the bowl and let the water out.

Should it not be possible to have access to the drain hose because, for example the appliance is built in the kitchen furniture, slightly loosen the drain filter after placing a bowl on the floor to let the water come out slowly.

At the end screw the filter again.

## Frost precautions

If the machine is installed in a place where the temperature could drop below 0°C, proceed as follows:

- Close the water tap and unscrew the water inlet hose from the tap.
- Place the end of the drain hose and the inlet hose in a bowl placed on the floor.
- Select the "DRAIN" programme DESCARGA and run it until the machine stops.
- Turn the programme selector dial to ANULACION (RESET).
- Press the ON/OFF button to switch the machine off.
- Remove the plug from the power socket.
- Screw the water inlet hose back on and put the drain hose back in its place.

By doing this, any water remaining in the machine is removed, avoiding ice forming and consequently damage to the appliance.

When you use the machine again, make sure that the ambient temperature is above 0°C.

## Something not working?

- i** If during the spin cycle the machine makes an unusual whistling noise, different from the noise made by traditional washing machines, this is due to a new type of motor.



If water is not visible in the drum, this is due to the modern technology of new washing machines that use less water than traditional machines.

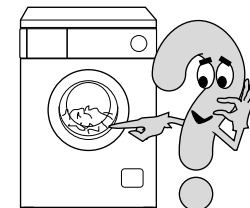

## Troubleshooting

If a problem arises, you can try to solve it yourself following the instructions below.

**If you call out an engineer when one of the following problems arises, or to repair a fault due to incorrect use, the call-out will be charged even if requested within the guarantee period.**

During machine operation the following alarm codes may be displayed:

- **E00:** problem with the water supply
- **E10:** problem with water draining
- **E20:** door open

Once the problem has been eliminated, press the START/PAUSE  button to restart the programme. If after all checks, the problem persists, contact your local AEG Service Force Centre.

Problem	Possible cause	Solution
The machine does not work	The ON/OFF button has not been depressed.	Depress the button.
	The main electrical fuse has blown.	Replace the fuse.
	The door is not properly closed ( <b>E20</b> ).	Close the door; the click of the lock should be heard.
	The plug is not connected.	Insert the plug.
	The START button has not been pressed.	Press the button.
	The DELAY START option has been selected.	Check the selected delay on the display.

Problem	Possible cause	Solution
The machine does not fill	The water tap is closed <b>(E00)</b> .	Open the water tap.
	The water inlet hose is squashed or kinked <b>(E00)</b> .	Check the whole length of the hose and remove the kink.
	The small filter of the water inlet hose is clogged <b>(E00)</b> .	Clean the filter.
	The door is not properly closed <b>(E20)</b> .	Close the door.
The machine fills then empties immediately	The end of the drain hose is too low.	Place the hose at the right height (see Installation section).
The machine does not empty and/or does not spin	The drain hose is squashed or kinked <b>(E10)</b> .	Check the whole length of the hose and remove the kink.
	The drain filter or the drain hose are clogged <b>(E10)</b> .	Clean the filter or check the hose.
	The RINSE HOLD option (stop with water in drum) has been selected.	Empty out the water by pressing the START button or selecting the PUMP OUT programme.
	The laundry is not evenly distributed inside the drum.	Redistribute the laundry manually in the drum.
There is water on the floor	Too much detergent has been used.	Measure detergent according to the manufacturer's instructions.
	An unsuitable detergent has been used that creates too much foam.	Use a suitable washing machine detergent.
	One of the connectors on the water inlet hose is leaking.	Check that the hose is firmly screwed on at both ends.
	The drain filter has not been properly screwed on after cleaning.	Fully screw the filter into place.

Problem	Possible cause	Solution
The machine vibrates or is noisy	The transit bolts have not been removed.	Check that the machine has been unpacked as described in the Installation section.
	The feet have not been adjusted.	Carefully level the machine.
	There is little laundry in the drum.	Correct operation of the machine is not affected.
The door will not open	The programme is still running.	Wait until the end of the programme before opening the door.
	The door lock has not yet released.	Wait about 2 minutes for the door lock to release.
	The water level is above the bottom edge of the door.	Before opening the door, the water must be emptied out.
	The machine is heating the water.	Wait until the end of the heating phase.

Problem	Possible cause	Solution
Spinning starts late or the machine does not spin	The unbalance detection device that prevents excessive vibration during spinning has cut in.	If the laundry is not evenly distributed inside the drum at the beginning of the spin cycle, the machine detects this and tries to redistribute it more evenly by means of a few drum rotations. Only when the laundry is more evenly distributed will the spin cycle be performed, at a lower speed, if the laundry is not evenly distributed. If, after about 15 minutes, the laundry is still tangled, the machine will not spin. Therefore, if the laundry is still wet at the end of the cycle, it is advisable to redistribute it manually inside the drum and to select the spin programme again.
The machine will not dry or the laundry is not dry enough	The water tap is not open (E00).	Open the water tap.
	The drain filter is clogged.	Clean the filter.
	The drying time or degree of dryness has not been selected.	Select the required function.
	An appropriate drying time has not been chosen.	Select the appropriate drying time suitable for the required degree of drying, according to the type of fabric (cottons or synthetics).
	There is too much laundry inside the appliance.	Reduce the load.

## Unsatisfactory washing results

### If the laundry looks grey and lime scale is found in the drum

- Too little detergent has been used.
- An unsuitable detergent has been used.
- Stubborn stains have not been treated prior to washing.
- The programme/temperature has not been correctly selected.

### If grey stains remain on the laundry

- Laundry stained with ointments, grease or oil has been washed with an insufficient amount of detergent.
- The temperature selected for the wash programme was too low.
- Fabric softener - especially the concentrated type - has come into direct contact with the laundry. Wash these stains immediately and pour fabric softener carefully.

### Foam is still visible even after the last rinse

- Modern detergents often produce foam, even in the last rinse. However the laundry has been completely rinsed.

### White residue is left on the laundry

- This is due to insoluble components in modern detergents and is therefore not the result of insufficient rinsing. Shake or brush the laundry. In future, it may be better to turn garments inside out before washing them. Check the choice of detergent; try using liquid detergents.

## Technical data

Height x Width x Depth	835x595x570 mm
Depth with door opened	1175 mm
Height adjustment	± 13 mm approx.
Net weight	88 kg approx.
Load (depending on programme)	5 kg max.
Use	domestic
Drum speed during washing	max. 55 rpm
Drum speed during spinning	1500/1200/900/700 rpm
Water pressure	1 - 10 bar (=10-100N/cm <sup>2</sup> = 0.1-1.0Mpa)

### CE This appliance complies with the following EC directives:

- 73/23/EEC of 19.2.1973 "Low voltage directive", including directive 93 / 68 / EEC
- 89/336/EEC of 3.5.1989 "Electromagnetic Compatibility Directive".

## Service

In the section "Something not working?" some problems that can be solved by yourself are listed. Read this section in the event of problems. If you are not able to find a solution, contact the Service centre. (Addresses and telephone numbers are given on the enclosed leaflet).

In all cases, explain your problem carefully, in order to facilitate troubleshooting: the engineer will be able to decide whether a service call is necessary.

Take note of the serial number (F-Nr.) and the product number (Prod. No.) indicated on the rating plate.

F-Nr. ....

Prod. No. ....

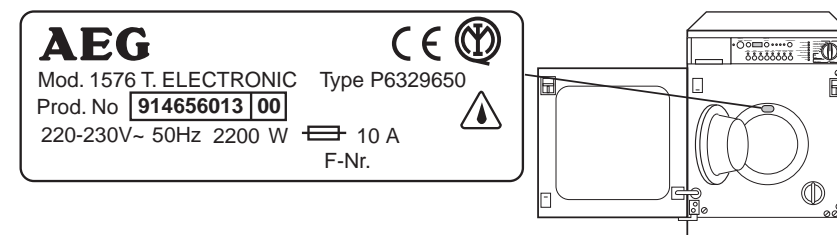

Furthermore, try to specify, as precisely as possible:

- The symptoms of the fault
- When the fault occurs

### When can a service visit be charged during the guarantee period?

- when it should have been possible to solve the problem by yourself, with the help of the troubleshooting chart (see section "Something not working?")
- when the engineer has to come out several times because he has not been given all the relevant information he needs and so, for example, has to fetch spare parts. Repeated trips can be avoided if you prepare your call to the Service centre as described above.

## Instructions for installation and electrical connection

### ⚠ Safety instructions for the installer

- This appliance is heavy, care should be taken when moving it.
- When unpacking the appliance, check that it is not damaged. If in doubt, do not use it and contact the retailer.
- All internal packing must be removed before using the appliance. Serious damage may be caused to the machine or adjacent furniture if the protective transit devices are not completely removed. Refer to the relevant paragraph.
- Any electrical work required to install this appliance must be carried out by a qualified electrician.
- Any plumbing work required to install this appliance must be carried out by a qualified plumber.
- After having installed the machine, check that it is not standing on its electrical supply cable.
- If the appliance is placed on a carpeted floor, ensure that air can circulate freely between the adjustable feet and the floor.
- The installation should comply with local water authority and building regulations requirements.
- Should the appliance power supply cable need to be replaced, this should be carried out by our Service Force Centre.

## Dimensions of the appliance

### Front view and side view

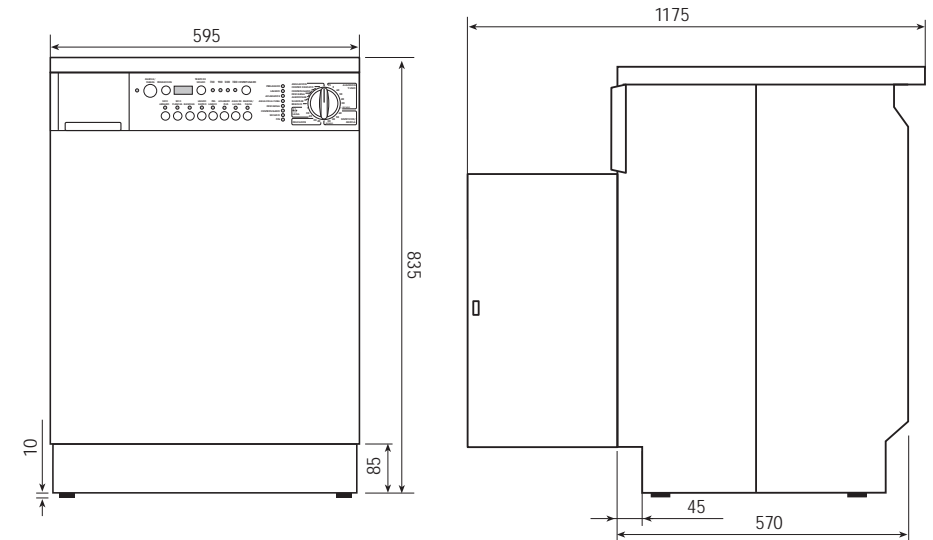

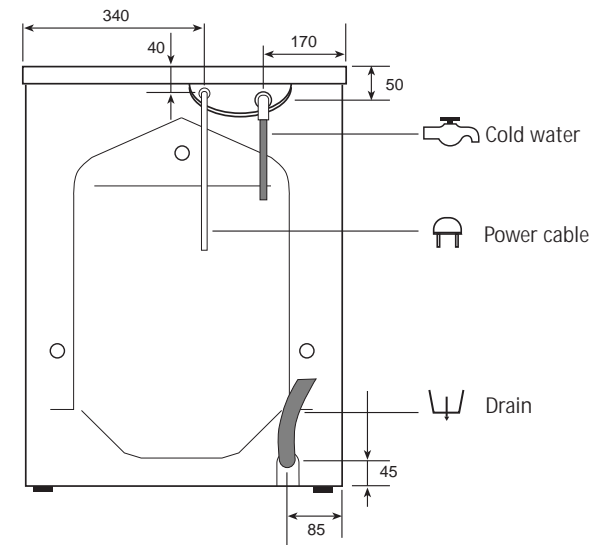

### Rear view





## Installation

### Unpacking

 All transit bolts and packing must be removed before using the appliance.

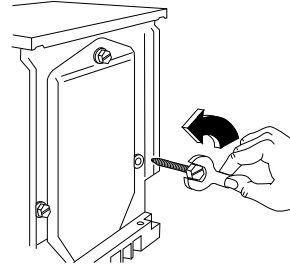
 Using a spanner, unscrew and remove the rear right-hand bolt and lay the machine on its back, taking care not to squash the hoses. This can be avoided by placing one of the corner packing pieces between the machine and the floor.



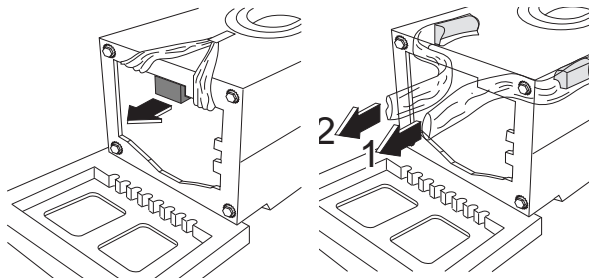

 Remove the polystyrene block from the bottom of the machine and release the two plastic bags by removing the adhesive strip.

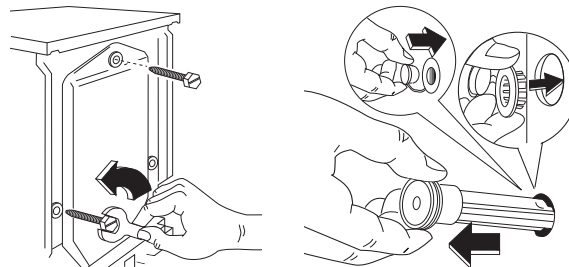

 Carefully remove the right-hand bag (1) then the left-hand bag (2) by pulling them towards the centre of the machine.

 Set the machine upright and remove the two remaining bolts from the back.



 Pull out the three plastic spacers from the holes into which the bolts were fitted.

 Plug the open holes with the plugs which you will find in the plastic bag containing the instruction booklet.

You are advised to keep all transit devices so that they can be refitted if the machine ever has to be transported again.

### Positioning

Install the machine on a flat hard floor.

Make sure that air circulation around the machine is not impeded by carpets, rugs etc.

- Before placing it on small tiles, apply a rubber coating.
- Never try to correct any unevenness in the floor by putting pieces of wood, cardboard or similar materials under the machine.
- If it is impossible to avoid positioning the machine next to a gas cooker or coal-burning stove, an insulating panel (85x57 cm) covered with aluminium foil on the side facing the cooker or stove, must be inserted between the two appliances;
- The machine must not be installed in rooms where the temperature can drop below 0.
- The water inlet hose and the drain hose must not be kinked.
- Please ensure that when the appliance is installed, it is easily accessible for the engineer in the event of a breakdown.

### Levelling

Carefully level by screwing the adjustable feet in or out. Never place cardboard, wood or similar materials under the machine to compensate for any unevenness in the floor.

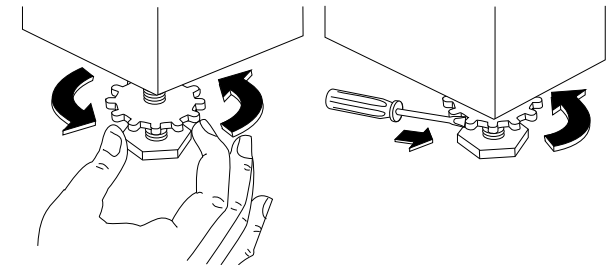

After having levelled the machine, tighten the lock nuts.



## Water inlet

Connect the water inlet hose to a separate tap with a 3/4" thread after having inserted the small filter "A" supplied with the machine.

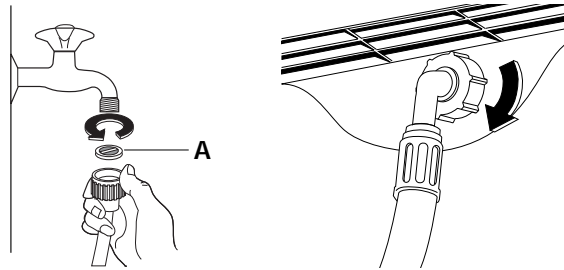

The other end of the inlet hose which connects to the machine can be turned in any direction. Simply loosen the fitting, rotate the hose and retighten the fitting, making sure there are no water leaks.

The inlet hose must not be lengthened. If it is too short and you do not wish to move the tap, you will have to purchase a new, longer hose specially designed for this type of use.

## Water drainage

The end of the drain hose can be positioned in three ways:

**Hooked over the edge of a sink using the plastic hose guide supplied with the machine.** In this case, make sure the end cannot come unhooked when the machine is emptying.

This could be done by tying it to the tap with a piece of string or attaching it to the wall.

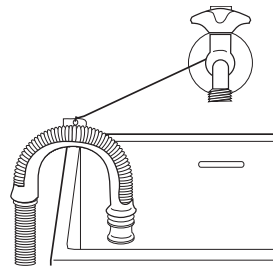

**In a sink drain pipe branch.** This branch must be above the trap so that the bend is at least 60 cm above the ground.

**Directly into a drain pipe at a height** of not less than 60 cm and not more than 90 cm.

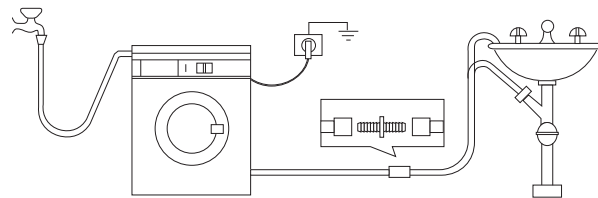

The end of the drain hose must always be **ventilated**, i.e. the inside diameter of the drain pipe must be larger than the outside diameter of the drain hose.

The drain hose must not be kinked. Run it along the floor; only the part near the drainage point must be raised.

## Electrical connection

This machine is designed to operate on a 220-230 V, single-phase, 50 Hz supply.

Check that your domestic electrical installation can take the maximum load required (2.2 kW), also taking into account any other appliances in use.

**Connect the machine to an earthed socket.**



**The manufacturer does not accept any responsibility for damage or injury through failure to comply with the above safety precaution.**

## Permanent connection

In the case of a permanent connection it is necessary that you install a double pole switch between the appliance and the electricity supply (mains), with a minimum gap of 3 mm between the switch contacts and of a type suitable for the required load in compliance with the current electrical regulations.

The switch must not break the yellow and green earth cable at any point.

This operation must be performed by a qualified electrician.

## Door reversal

The opening direction of the outer door on this machine can be reversed. To carry out this operation, proceed as follows:

- ☞ Disengage the end of the catch (1) from the door and turn it 90° to remove it from its seat (Fig. A).
- ☞ Using a screwdriver, turn plastic plug (2) 90° to remove it from its seat (Fig. A).
- ☞ Fit plug (2) in the hole left free by catch (1) and turn it 90° to lock it in place (Fig. B).
- ☞ Fit catch (1) into the hole from which plug (2) was removed and turn it 90°, making sure that the latching tooth is facing towards the right (Fig. B).
- ☞ Remove the door by unscrewing the screws securing it to the bottom hinge (3 - Fig. A).
- ☞ Unscrew the two plastic screws (4 - Fig. A) and fit them on the opposite side (4 - Fig. B).
- ☞ Remove the catch hook (5 - Fig. A) by inserting a screwdriver into the upper hole and pushing downwards.
- ☞ Remove plate (6) by inserting a screwdriver into the bottom hole and pushing upwards (Fig. A).
- ☞ Refit the catch hook (5) and plate (6) on the opposite sides (Fig. B).
- ☞ Remove the door catch (7) and plate (8) as explained in paragraph 7.
- ☞ Turn the door 180°.
- ☞ Refit the door catch (7) and plate (8), reversing their position and pressing firmly to engage the hook (Fig. B).
- ☞ Fit the door onto the machine. Insert the top pin first, then the bottom pin into the hinge (3- Fig. B); finally screw the hinge onto the washing machine.

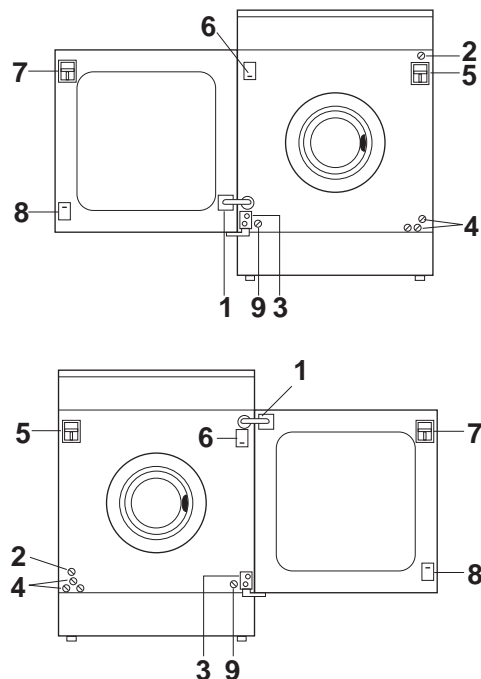

- ☞ Check that the door is aligned with the appliance. To do this, loosen screw (9 - Fig. B) by a couple of turns and re-tighten when alignment is correct.
- ☞ Fit the flexible end of the door catch (1 - Fig. B) into the location provided in the door.

## Fitting a door panel

The door of this machine has mouldings to allow fitting of a decorative panel (stainless steel sheet, laminated plastic, wood etc.) to match with the existing kitchen units.

The dimensions of the panel must be as follows:

Width	588 mm
Height	588 mm
Maximum thickness	4 mm

To fit the panel, remove the moulding by unscrewing its fixing screws. Position the panel, then refit the moulding, making sure that it comes into contact with and firmly clamps the panel.